

Technical data sheet



Product features

Food display island chilled GN 3-1/1 Wenge

Model	SAP Code	00012099
--------------	-----------------	----------



- Buffet type: BLUE - cooled, dynamic cooling
- Device properties: Chilled
- Number of GN / EN: 3
- GN / EN size in device: GN 1/1
- GN device depth: 150
- Minimum device temperature [°C]: 4
- Maximum device temperature [°C]: 8

SAP Code	00012099	Loading	230 V / 1N - 50 Hz
Net Width [mm]	1169	Number of GN / EN	3
Net Depth [mm]	760	GN / EN size in device	GN 1/1
Net Height [mm]	1288	GN device depth	150
Net Weight [kg]	121.80	Minimum device temperature [°C]	4
Power electric [kW]	0.247	Maximum device temperature [°C]	8

Technical data sheet



Technical drawing

Food display island chilled GN 3-1/1 Wenge

Model

SAP Code

00012099

A= ELECTRICAL CONNECTION
 D= WATER DISCHARGE Ø16
 E= GAS CONNECTION Ø8 Ø10
 F= WATER BOX

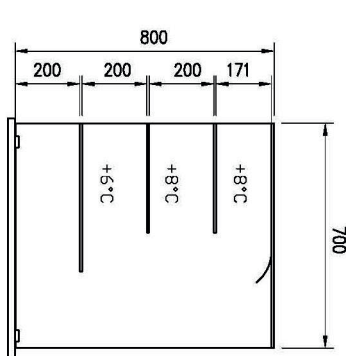
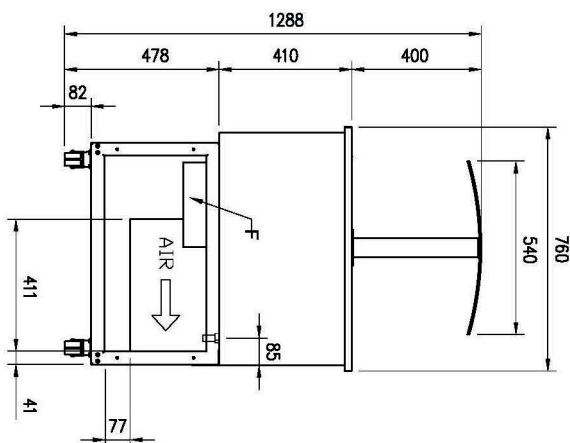
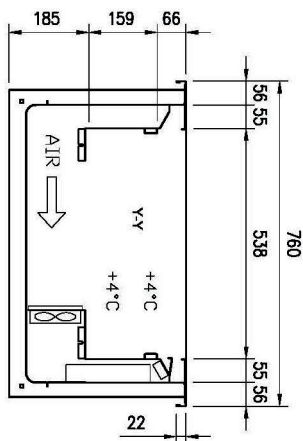
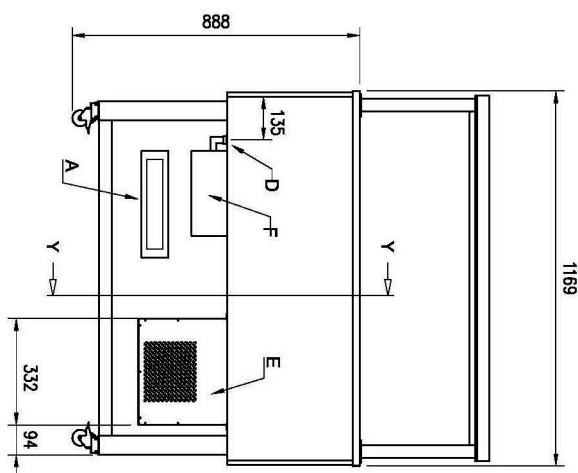
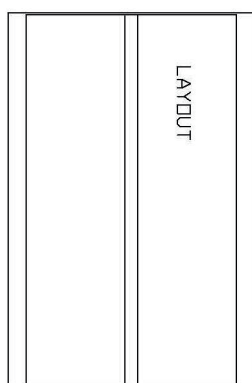

PLATINUM

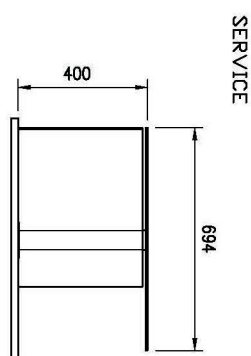

SERVICE

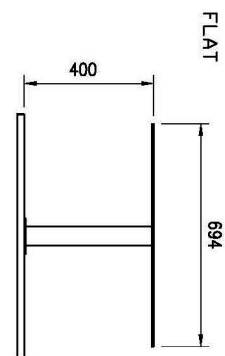

FLAT

Technical data sheet



Product benefits

Food display island chilled GN 3-1/1 Wenge

Model

SAP Code

00012099

1

Dynamic cooling

constant temperature in all places of the refrigerated space

- greater hygienic safety of chilled food

2

All-stainless steel construction

harmless to health for contact with food
robustness

- perfect sanitation
- long service life

3

Rounded corners

basins without sharp edges and corners

- higher hygienic safety
- time saving due to easy cleaning

4

GN insertion up to 150mm

variability of use

- possibility of cooling different types of food and larger volumes
- saving time, space, costs

5

LED lighting

variability of use

- economical lighting
- attractive appearance

6

Travel wheels

portable buffet table

- greater flexibility in dispensing
- possibility of use at banquets
- easier and safer handling

7

Breathing galley with trigger

galerka made of hygienic Plexiglas with motorized displacement

- hygienic food protection
- the possibility of sealing before dispensing - extending the shelf life of food

Technical data sheet



Technical parameters

Food display island chilled GN 3-1/1 Wenge

Model	SAP Code	00012099
--------------	-----------------	----------

1. SAP Code:

00012099

2. Net Width [mm]:

1169

3. Net Depth [mm]:

760

4. Net Height [mm]:

1288

5. Net Weight [kg]:

121.80

6. Gross Width [mm]:

1233

7. Gross depth [mm]:

1012

8. Gross Height [mm]:

1100

9. Gross Weight [kg]:

136.00

10. Device type:

Electric unit

11. Buffet type:

BLUE - cooled, dynamic cooling

12. Device properties:

Chilled

13. Exterior color of the device:

Hemlock

14. Power electric [kW]:

0.247

15. Loading:

230 V / 1N - 50 Hz

16. Number of GN / EN:

3

17. GN / EN size in device:

GN 1/1

18. GN device depth:

150

19. Minimum device temperature [°C]:

4

20. Maximum device temperature [°C]:

8